

MMBT2907AL, SMMBT2907AL

General Purpose Transistors

PNP Silicon

Features

- S Prefix for Automotive and Other Applications Requiring Unique Site and Control Change Requirements; AEC-Q101 Qualified and PPAP Capable
- These Devices are Pb-Free, Halogen Free/BFR Free and are RoHS Compliant

MAXIMUM RATINGS

Rating	Symbol	Value	Unit
Collector-Emitter Voltage	V_{CEO}	-60	Vdc
Collector-Base Voltage	V_{CBO}	-60	Vdc
Emitter-Base Voltage	V_{EBO}	-5.0	Vdc
Collector Current - Continuous	I_C	-600	mAdc
Collector Current - Peak (Note 3)	I_{CM}	-1200	mAdc

THERMAL CHARACTERISTICS

Characteristic	Symbol	Max	Unit
Total Device Dissipation - FR-5 Board (Note 1) @ $T_A = 25^\circ\text{C}$ Derate above 25°C	P_D	225 1.8	mW mW/ $^\circ\text{C}$
Thermal Resistance, Junction-to-Ambient	$R_{\theta JA}$	556	$^\circ\text{C}/\text{W}$
Total Device Dissipation - Alumina Substrate, (Note 2) @ $T_A = 25^\circ\text{C}$ Derate above 25°C	P_D	300 2.4	mW mW/ $^\circ\text{C}$
Thermal Resistance, Junction-to-Ambient	$R_{\theta JA}$	417	$^\circ\text{C}/\text{W}$
Total Device Dissipation - Heat Spreader or equivalent, (Note 4) @ $T_A = 25^\circ\text{C}$	P_D	350	mW
Thermal Resistance, Junction-to-Ambient	$R_{\theta JA}$	357	$^\circ\text{C}/\text{W}$
Junction and Storage Temperature	T_J, T_{stg}	-55 to +150	$^\circ\text{C}$

Stresses exceeding those listed in the Maximum Ratings table may damage the device. If any of these limits are exceeded, device functionality should not be assumed, damage may occur and reliability may be affected.

1. FR-5 = $1.0 \times 0.75 \times 0.062$ in.
2. Alumina = $0.4 \times 0.3 \times 0.024$ in. 99.5% alumina.
3. Reference SOA curve.
4. Heat Spreader or equivalent = 450 mm^2 , 2 oz.



ON Semiconductor®

www.onsemi.com

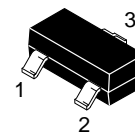
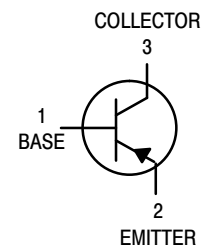

SOT-23 (TO-236AB)
CASE 318
STYLE 6

MARKING DIAGRAM

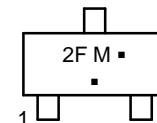

2F = Device Code
M = Date Code*
▪ = Pb-Free Package

(Note: Microdot may be in either location)

*Date Code orientation and/or overbar may vary depending upon manufacturing location.

ORDERING INFORMATION

Device	Package	Shipping†
MMBT2907ALT1G SMMBT2907ALT1G	SOT-23 (Pb-Free)	3000 / Tape & Reel
MMBT2907ALT3G SMMBT2907ALT3G	SOT-23 (Pb-Free)	10,000 / Tape & Reel

†For information on tape and reel specifications, including part orientation and tape sizes, please refer to our Tape and Reel Packaging Specifications Brochure, BRD8011/D.

MMBT2907AL, SMMBT2907AL

ELECTRICAL CHARACTERISTICS (T_A = 25°C unless otherwise noted)

Characteristic	Symbol	Min	Max	Unit
OFF CHARACTERISTICS				
Collector-Emitter Breakdown Voltage (Note 5) (I _C = -1.0 mA, I _B = 0) (I _C = -10 mA, I _B = 0)	V _{(BR)CEO}	-60 -60	-	Vdc
Collector-Base Breakdown Voltage (I _C = -10 μA, I _E = 0)	V _{(BR)CBO}	-60	-	Vdc
Emitter-Base Breakdown Voltage (I _E = -10 μA, I _C = 0)	V _{(BR)EBO}	-5.0	-	Vdc
Collector Cutoff Current (V _{CE} = -30 Vdc, V _{EB(off)} = -0.5 Vdc)	I _{CEX}	-	-50	nAdc
Collector Cutoff Current (V _{CB} = -50 Vdc, I _E = 0) (V _{CB} = -50 Vdc, I _E = 0, T _A = 125°C)	I _{CBO}	-	-0.010 -10	μAdc
Base Cutoff Current (V _{CE} = -30 Vdc, V _{EB(off)} = -0.5 Vdc)	I _{BL}	-	-50	nAdc

ON CHARACTERISTICS

DC Current Gain (I _C = -0.1 mA, V _{CE} = -10 Vdc) (I _C = -1.0 mA, V _{CE} = -10 Vdc) (I _C = -10 mA, V _{CE} = -10 Vdc) (I _C = -150 mA, V _{CE} = -10 Vdc) (I _C = -500 mA, V _{CE} = -10 Vdc) (Note 5)	h _{FE}	75 100 100 100 50	-	-
Collector-Emitter Saturation Voltage (Note 5) (I _C = -150 mA, I _B = -15 mA) (Note 5) (I _C = -500 mA, I _B = -50 mA)	V _{CE(sat)}	-	-0.4 -1.6	Vdc
Base-Emitter Saturation Voltage (Note 5) (I _C = -150 mA, I _B = -15 mA) (I _C = -500 mA, I _B = -50 mA)	V _{BE(sat)}	-	-1.3 -2.6	Vdc

SMALL-SIGNAL CHARACTERISTICS

Current-Gain - Bandwidth Product (Notes 5, 6), (I _C = -50 mA, V _{CE} = -20 Vdc, f = 100 MHz)	f _T	200	-	MHz
Output Capacitance (V _{CB} = -10 Vdc, I _E = 0, f = 1.0 MHz)	C _{obo}	-	8.0	pF
Input Capacitance (V _{EB} = -2.0 Vdc, I _C = 0, f = 1.0 MHz)	C _{ibo}	-	30	pF

SWITCHING CHARACTERISTICS

Turn-On Time	(V _{CC} = -30 Vdc, I _C = -150 mA, I _{B1} = -15 mA)	t _{on}	-	45	ns
Delay Time		t _d	-	10	
Rise Time		t _r	-	40	
Turn-Off Time	(V _{CC} = -6.0 Vdc, I _C = -150 mA, I _{B1} = I _{B2} = -15 mA)	t _{off}	-	100	
Storage Time		t _s	-	80	
Fall Time		t _f	-	30	

5. Pulse Test: Pulse Width ≤ 300 μs, Duty Cycle ≤ 2.0%.
6. f_T is defined as the frequency at which |h_{fe}| extrapolates to unity.

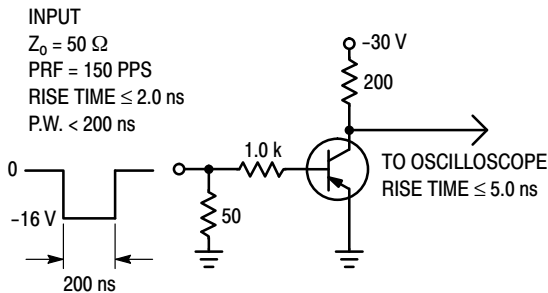

Figure 1. Delay and Rise Time Test Circuit

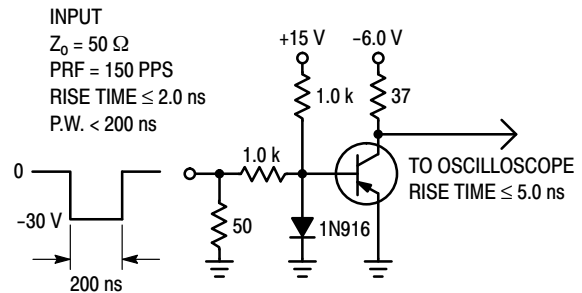

Figure 2. Storage and Fall Time Test Circuit

MMBT2907AL, SMMBT2907AL

TYPICAL CHARACTERISTICS



Figure 3. DC Current Gain



Figure 4. Collector Saturation Region

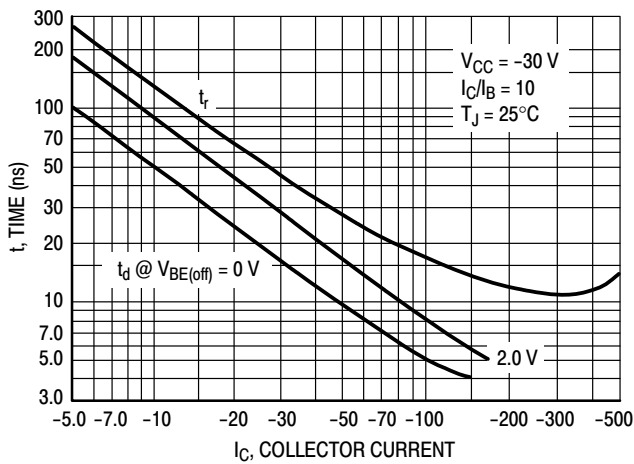

Figure 5. Turn-On Time

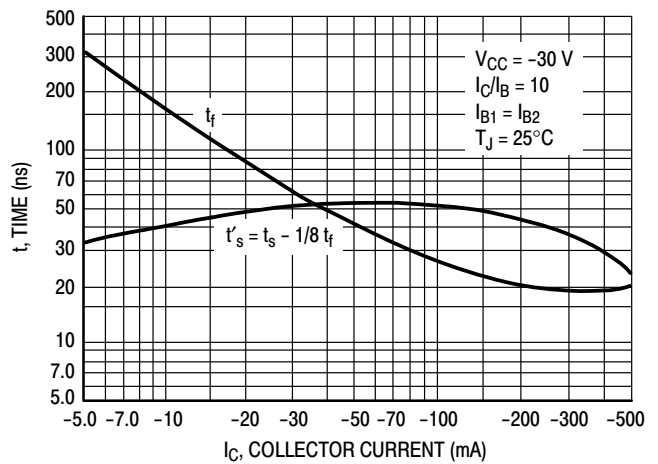

Figure 6. Turn-Off Time

MMBT2907AL, SMMBT2907AL

TYPICAL SMALL-SIGNAL Characteristics NOISE FIGURE

$V_{CE} = 10 \text{ Vdc}$, $T_A = 25^\circ\text{C}$

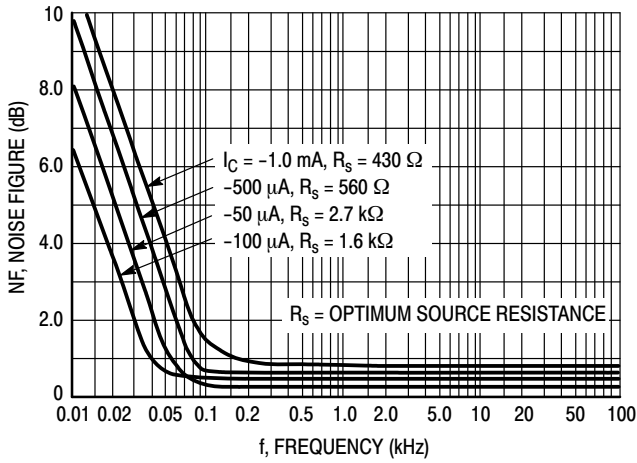

Figure 7. Frequency Effects

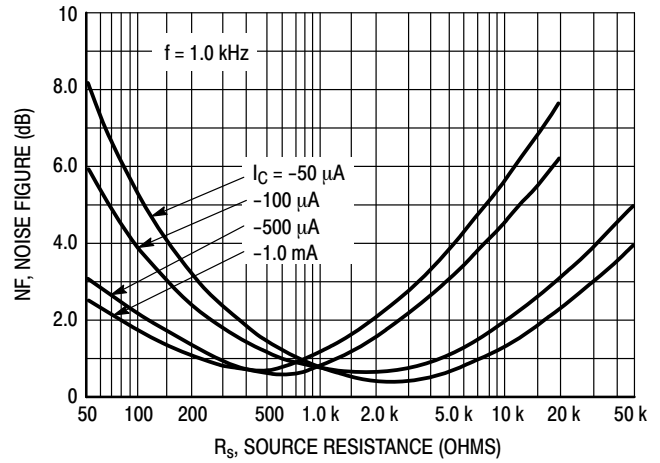

Figure 8. Source Resistance Effects

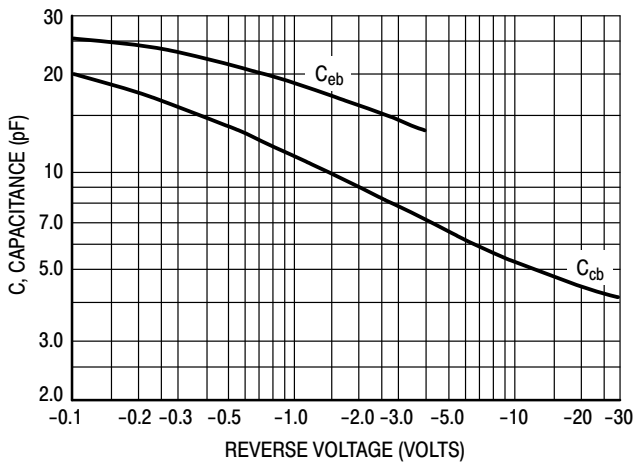

Figure 9. Capacitances

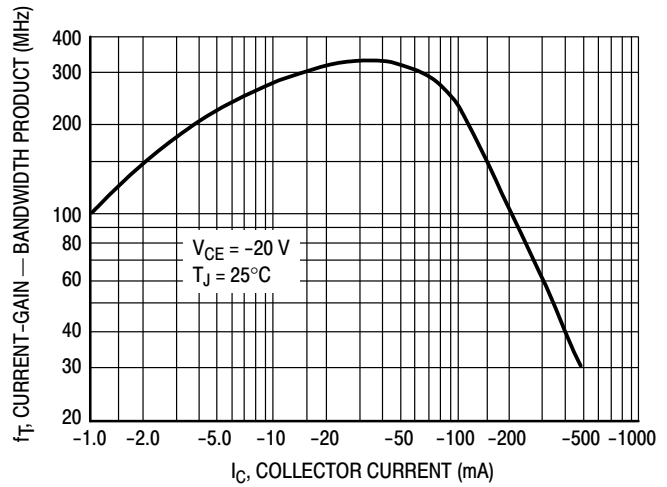

Figure 10. Current-Gain - Bandwidth Product

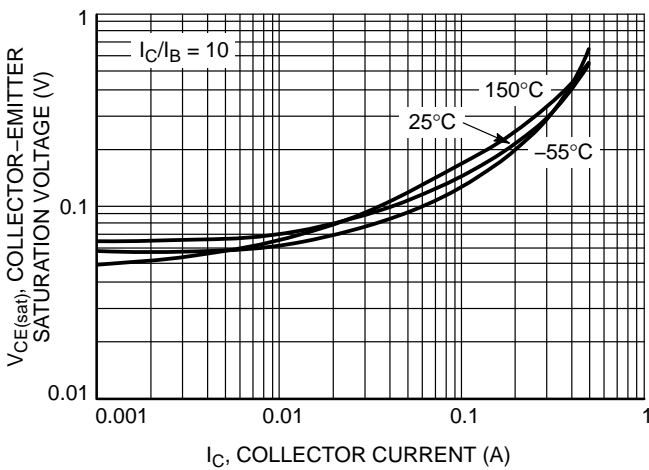

Figure 11. Collector-Emitter Saturation Voltage vs. Collector Current

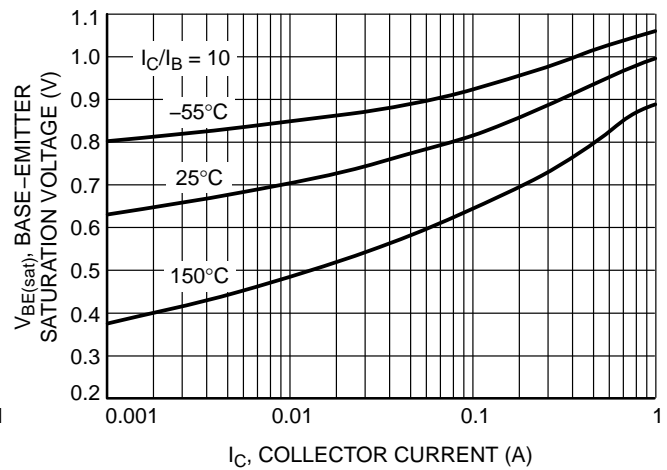

Figure 12. Base-Emitter Saturation Voltage vs. Collector Current

MMBT2907AL, SMMBT2907AL

TYPICAL SMALL-SIGNAL Characteristics NOISE FIGURE

$V_{CE} = 10 \text{ Vdc}$, $T_A = 25^\circ\text{C}$

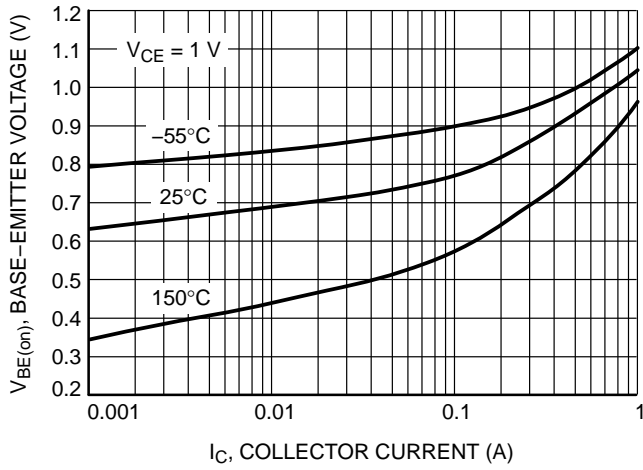

Figure 13. Base Emitter Voltage vs. Collector Current

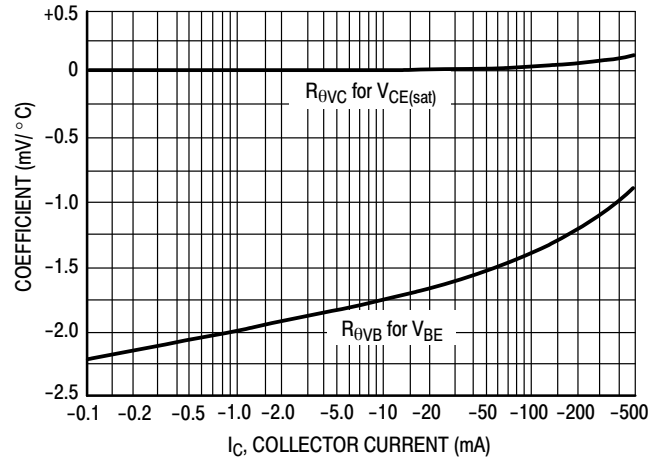

Figure 14. Temperature Coefficients

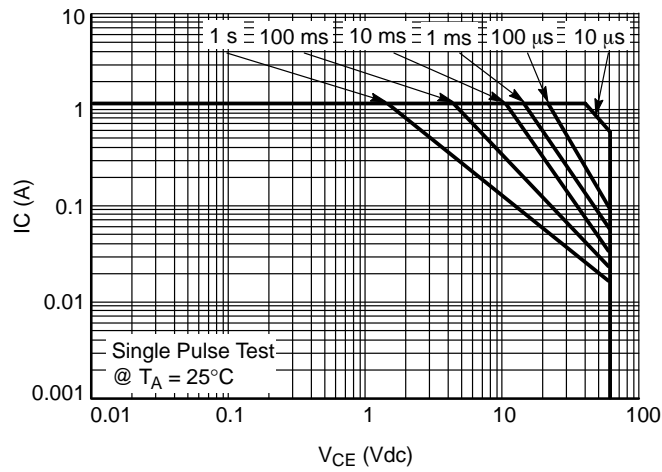
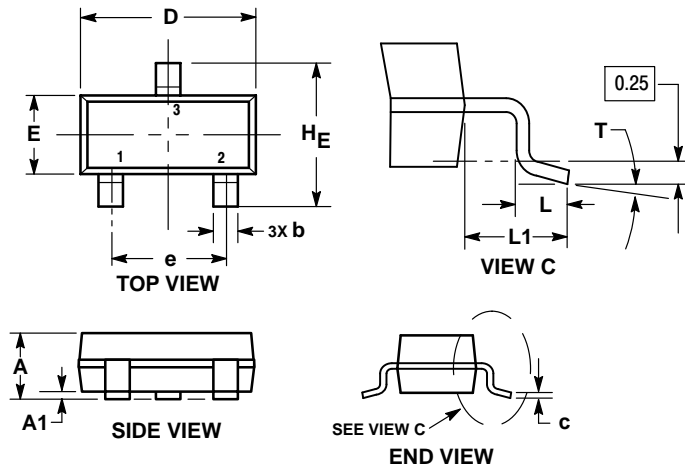

Figure 15. Safe Operating Area

MMBT2907AL, SMMBT2907AL

PACKAGE DIMENSIONS

SOT-23 (TO-236)
CASE 318-08
ISSUE AR



NOTES:

1. DIMENSIONING AND TOLERANCING PER ASME Y14.5M, 1994.
2. CONTROLLING DIMENSION: MILLIMETERS.
3. MAXIMUM LEAD THICKNESS INCLUDES LEAD FINISH. MINIMUM LEAD THICKNESS IS THE MINIMUM THICKNESS OF THE BASE MATERIAL.
4. DIMENSIONS D AND E DO NOT INCLUDE MOLD FLASH, PROTRUSIONS, OR GATE BURRS.

DIM	MILLIMETERS			INCHES		
	MIN	NOM	MAX	MIN	NOM	MAX
A	0.89	1.00	1.11	0.035	0.039	0.044
A1	0.01	0.06	0.10	0.000	0.002	0.004
b	0.37	0.44	0.50	0.015	0.017	0.020
c	0.08	0.14	0.20	0.003	0.006	0.008
D	2.80	2.90	3.04	0.110	0.114	0.120
E	1.20	1.30	1.40	0.047	0.051	0.055
e	1.78	1.90	2.04	0.070	0.075	0.080
L	0.30	0.43	0.55	0.012	0.017	0.022
L1	0.35	0.54	0.69	0.014	0.021	0.027
HE	2.10	2.40	2.64	0.083	0.094	0.104
T	0°	---	10°	0°	---	10°

STYLE 6:

- PIN 1. BASE
- EMITTER
- COLLECTOR

RECOMMENDED SOLDERING FOOTPRINT

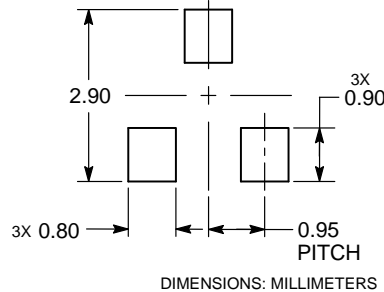

ON Semiconductor and are trademarks of Semiconductor Components Industries, LLC dba ON Semiconductor or its subsidiaries in the United States and/or other countries. ON Semiconductor owns the rights to a number of patents, trademarks, copyrights, trade secrets, and other intellectual property. A listing of ON Semiconductor's product/patent coverage may be accessed at www.onsemi.com/site/pdf/Patent-Marketing.pdf. ON Semiconductor reserves the right to make changes without further notice to any products herein. ON Semiconductor makes no warranty, representation or guarantee regarding the suitability of its products for any particular purpose, nor does ON Semiconductor assume any liability arising out of the application or use of any product or circuit, and specifically disclaims any and all liability, including without limitation special, consequential or incidental damages. Buyer is responsible for its products and applications using ON Semiconductor products, including compliance with all laws, regulations and safety requirements or standards, regardless of any support or applications information provided by ON Semiconductor. "Typical" parameters which may be provided in ON Semiconductor data sheets and/or specifications can and do vary in different applications and actual performance may vary over time. All operating parameters, including "Typicals" must be validated for each customer application by customer's technical experts. ON Semiconductor does not convey any license under its patent rights nor the rights of others. ON Semiconductor products are not designed, intended, or authorized for use as a critical component in life support systems or any FDA Class 3 medical devices or medical devices with a same or similar classification in a foreign jurisdiction or any devices intended for implantation in the human body. Should Buyer purchase or use ON Semiconductor products for any such unintended or unauthorized application, Buyer shall indemnify and hold ON Semiconductor and its officers, employees, subsidiaries, affiliates, and distributors harmless against all claims, costs, damages, and expenses, and reasonable attorney fees arising out of, directly or indirectly, any claim of personal injury or death associated with such unintended or unauthorized use, even if such claim alleges that ON Semiconductor was negligent regarding the design or manufacture of the part. ON Semiconductor is an Equal Opportunity/Affirmative Action Employer. This literature is subject to all applicable copyright laws and is not for resale in any manner.

PUBLICATION ORDERING INFORMATION

LITERATURE FULFILLMENT:

Literature Distribution Center for ON Semiconductor
19521 E. 32nd Pkwy, Aurora, Colorado 80011 USA
Phone: 303-675-2175 or 800-344-3860 Toll Free USA/Canada
Fax: 303-675-2176 or 800-344-3867 Toll Free USA/Canada
Email: orderlit@onsemi.com

N. American Technical Support: 800-282-9855 Toll Free
USA/Canada
Europe, Middle East and Africa Technical Support:
Phone: 421 33 790 2910
Japan Customer Focus Center
Phone: 81-3-5817-1050

ON Semiconductor Website: www.onsemi.com

Order Literature: <http://www.onsemi.com/orderlit>

For additional information, please contact your local Sales Representative